

POR-0408V



POR-0408 V

- Manigioncini ad incollaggio biadesivo
- Small pullhandles with self-adhesive fixing
- Stosgriffe selbstklebend

AN - CR - NS

	C	17	17	17
	260	•		
B	410		•	
	560			•

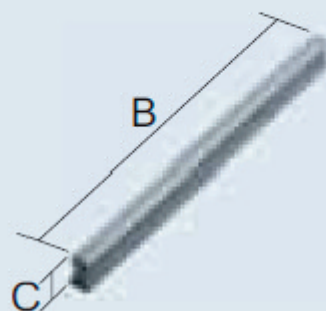

SRHA01

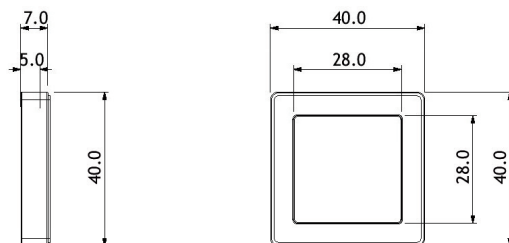

Coppia di maniglie quadrate autoadesive per porte scorrevoli
Speciale adesivo 3M VHB® ad alta resistenza
Realizzata in acciaio inox Aisi 304
Pulizia del vetro con alcool isopropilico consigliata

Pair of self-adhesive squared handles for glass sliding doors
Special high resistance 3M VHB® tape
Aisi 304 stainless steel manufacturing
Glass cleaning with isopropyl alcohol is recommended

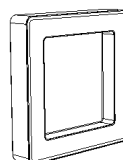

RHA04

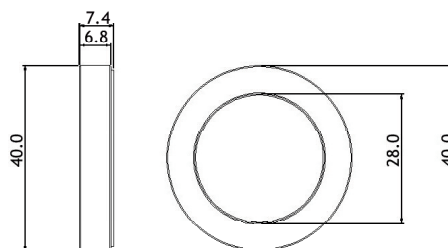
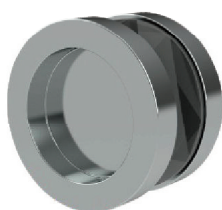

Coppia di maniglie tonde autoadesive per porte scorrevoli
Speciale adesivo 3M VHB® ad alta resistenza
Realizzata in acciaio inox Aisi 304
Pulizia del vetro con alcool isopropilico consigliata

Pair of self-adhesive round handles for glass sliding doors
Special high resistance 3M VHB® tape
Aisi 304 stainless steel manufacturing
Glass cleaning with isopropyl alcohol is recommended

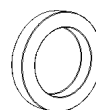

GRH03

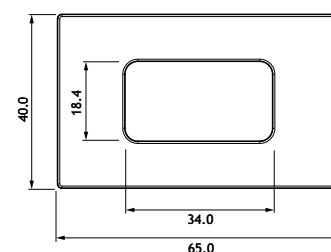
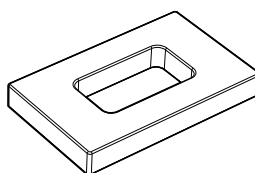
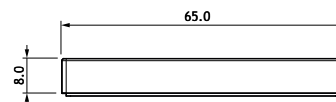
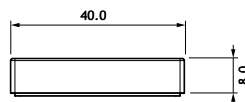

Coppia di maniglie rettangolari autoadesive per box doccia
Speciale adesivo 3M VHB ® ad alta resistenza
Realizzate in lega di alluminio
Pulizia del vetro con alcool isopropilico consigliata

Pair of rectangular self-adhesive handles for shower cabin
Special high resistance 3M VHB ® tape
Aluminium alloy manufacturing
Glass cleaning with isopropyl alcohol is recommended

IPA



Alcool isopropilico in confezione spray 200 ml
Da utilizzarsi per la pulizia del vetro
Indispensabile per la corretta adesione di guarnizioni e maniglie autoadesive

Isopropyl alcohol in spray pack, 200 ml
To be used for glass cleaning
Essential for the proper adhesion of self-adhesive handles and seals

--	--	--	--

POMOLI

DOOR KNOBS

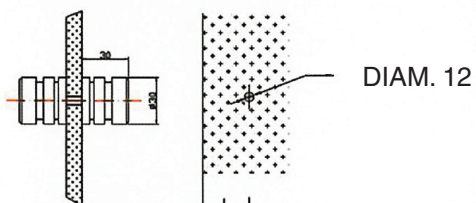
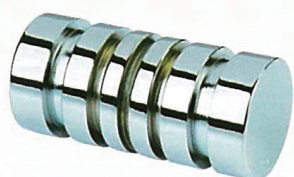

POMOLO 812

32*30 disponibile con finitura cromo lucido e nikel satinato

DOOR KNOB 812

32*30 available in bright chrome and nikel satin finishing

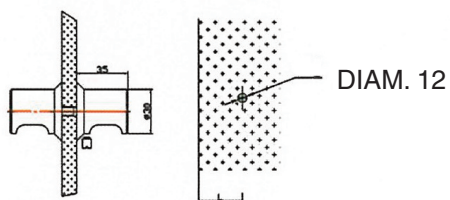

POMOLO 813

40*35 disponibile con finitura cromo lucido e nikel satinato

DOOR KNOB 813

40*35 available in bright chrome and nikel satin finishing

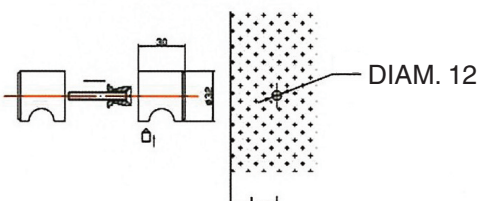
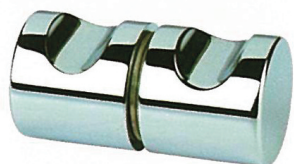

POMOLO 815

32*30 disponibile con finitura cromo lucido e nikel satinato

DOOR KNOB 815

32*30 available in bright chrome and nikel satin finishing

**ACCESSORI PER BOX DOCCIA
E VETRO TEMPERATO**

**SHOWER BOX AND TEMPERED
GLASS ACCESSORIES**

**MANIGLIONI
E BARRE STABILIZZANTI**

**PULL HANDLES AND STEADY
SUPPORTING BARS**

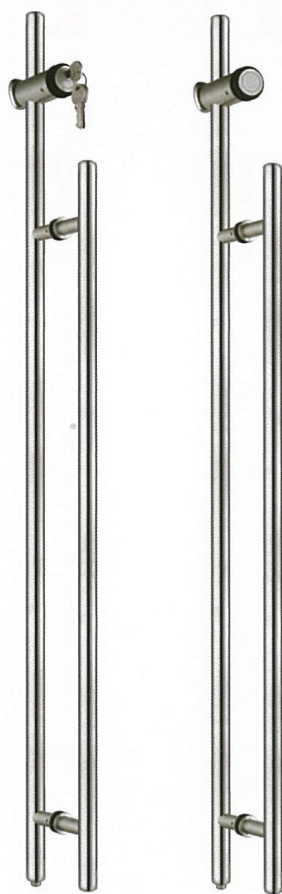

SA-8200B1

SA-8200B2

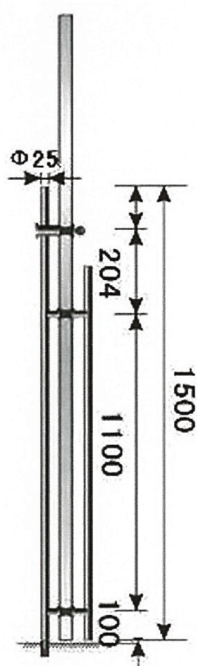

**MANIGLIONE TUBOLARE CON SERRATURA
SA-8200B1**

diam. mm. 25 - altezza cm. 150
disponibile con finitura cromo lucido e nikel satinato
materiale acciaio inossidabile

TUBULAR PULL HANDLE WITH LOCK SA-8200B1

diam. mm. 25 - height cm. 150
available in bright chrome and nikel satin finishing
material stainless steel

**MANIGLIONE TUBOLARE SENZA SERRATURA
SA-8200B2**

diam. mm. 25 - altezza cm. 150
disponibile con finitura cromo lucido e nikel satinato
materiale acciaio inossidabile

TUBULAR PULL HANDLE NO LOCK SA-8200B2

diam. mm. 25 - height cm. 150
available in bright chrome and nikel satin finishing
material stainless steel



BARRA STABILIZZANTE 522

disponibile in formato cm.120 muro a vetro,
con finitura cromo lucido e nikel satinato

STEADY SUPPORTING BAR 522

available in extensible sizes cm.120 wall to glass,
in bright chrome and nikel satin finishing

**ACCESSORI PER BOX DOCCIA
E VETRO TEMPERATO**

**SHOWER BOX AND TEMPERED
GLASS ACCESSORIES**

**MANIGLIONI
E BARRE STABILIZZANTI**

**PULL HANDLES AND STEADY
SUPPORTING BARS**

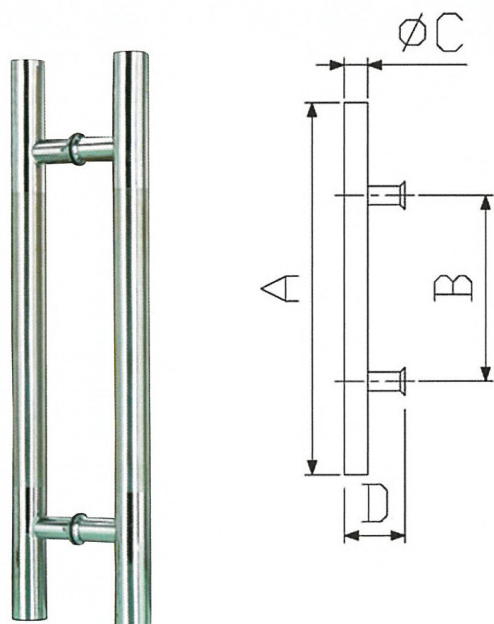

Ø fori 12 mm.

C= 25 cm. - 25 cm. - 32 cm.

MANIGLIONE 104

Disponibile con finitura cromo lucido e nikel satinato nei formati cm. 30 - cm. 60 - cm. 120
materiale acciaio inossidabile

PULL HANDLE 104

Available in bright chrome and nikel satin finishing with length cm. 30 - cm. 60 - cm. 120
material stainless steel

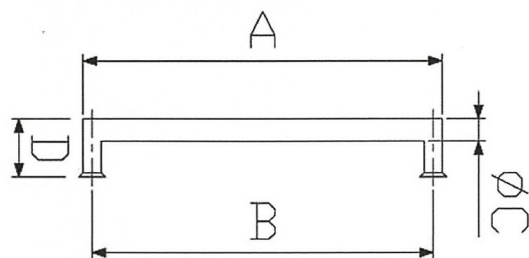
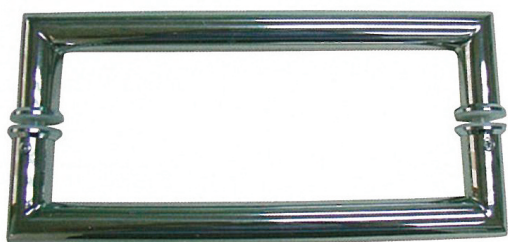

A= 30 cm. - 60 cm. - 120 cm.

B= 27,5 cm. - 57,5 cm. - 117,5 cm.

C= 25 cm. - 25 cm. - 30 cm.

MANIGLIONE 117

Disponibile con finitura cromo lucido e nikel satinato nei formati cm. 30 - cm. 60 - cm. 120
materiale acciaio inossidabile

PULL HANDLE 117

Available in bright chrome and nikel satin finishing with length cm. 30 - cm. 60 - cm. 120
material stainless steel

**BARRA STABILIZZANTE QUADRATA IN
 OTTONE**
BRASS SQUARE SUPPORTING BAR
MANIGLIONI SEZIONE TONDA

A		B	
CM	CROMATURA	INTERASSE	PREZZO
20	LUCIDO/SATINATO	13 CM	
30	LUCIDO/SATINATO	20 CM	
45	LUCIDO/SATINATO	30 CM	
60	LUCIDO/SATINATO	40 CM	
90	LUCIDO/SATINATO	70 CM	
120	LUCIDO/SATINATO	90 CM	

MANIGLIONI SEZIONE QUADRATA

A		B	
CM	CROMATURA	INTERASSE	PREZZO
20	LUCIDO/SATINATO	13 CM	
30	LUCIDO/SATINATO	20 CM	
45	LUCIDO/SATINATO	30 CM	
60	LUCIDO/SATINATO	40 CM	
90	LUCIDO/SATINATO	65 CM	

SK02

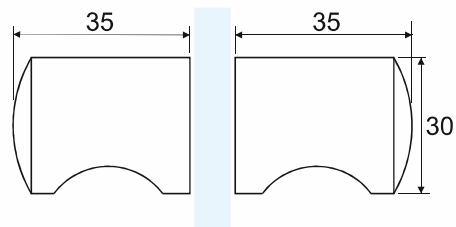
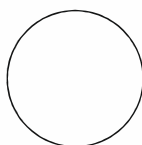

Coppia di pomoli cilindrici con presa per box doccia e porte in vetro
Meccanismo interno di centratura
Realizzati in fusione di lega AC41A ad alta resistenza

Pair of cylindrical knobs with handle grip for shower rooms and glass doors
Inner centering device
Diecast high resistance AC41A alloy manufacturing

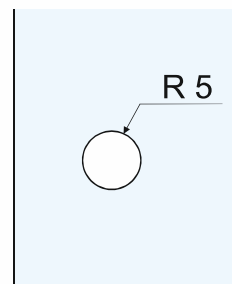

SK03

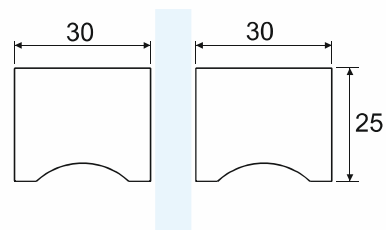
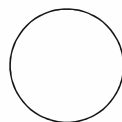

Coppia di pomoli cilindrici con presa per box doccia e porte in vetro
Meccanismo interno di centratura
Realizzati in fusione di lega AC41A ad alta resistenza

Pair of cylindrical knobs with handle grip for shower rooms and glass doors
Inner centering device
Diecast high resistance AC41A alloy manufacturing

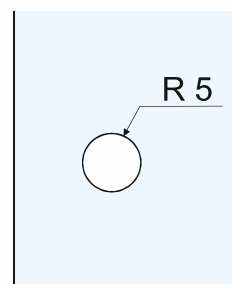

SK04

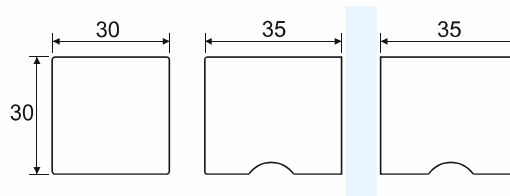

Coppia di pomoli a sezione quadrata con presa per box doccia e porte in vetro
Meccanismo interno di centratura
Realizzati in fusione di lega AC41A ad alta resistenza

Pair of square square section knobs with handle grip for shower rooms and glass doors
Inner centering device
Diecast high resistance AC41A alloy manufacturing

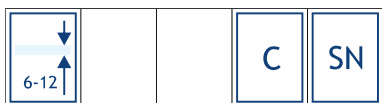
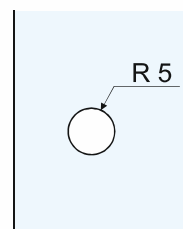

SK06

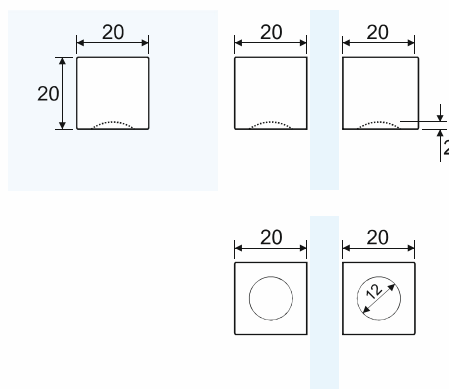

Coppia di pomoli a sezione quadrata con presa per box doccia e porte in vetro
Meccanismo interno di centratura
Realizzati in fusione di ottone

Pair of square section knobs with handle grip for shower rooms and glass doors
Inner centering device
Diecast brass manufacturing

